

Next generation COMINT RECEIVER PLATFORM HUGIN 4000

DATA SHEET

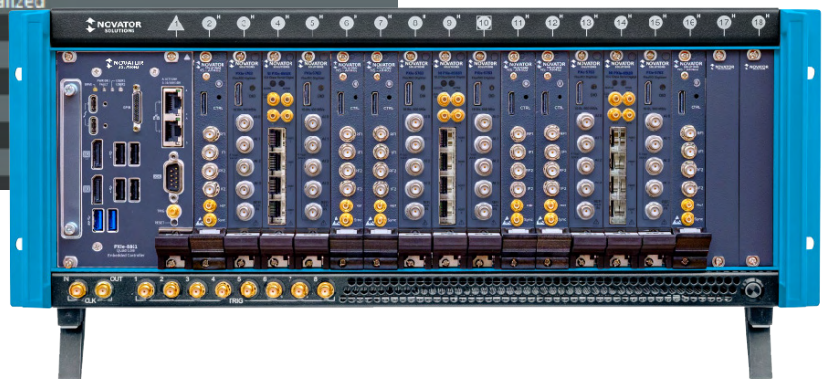
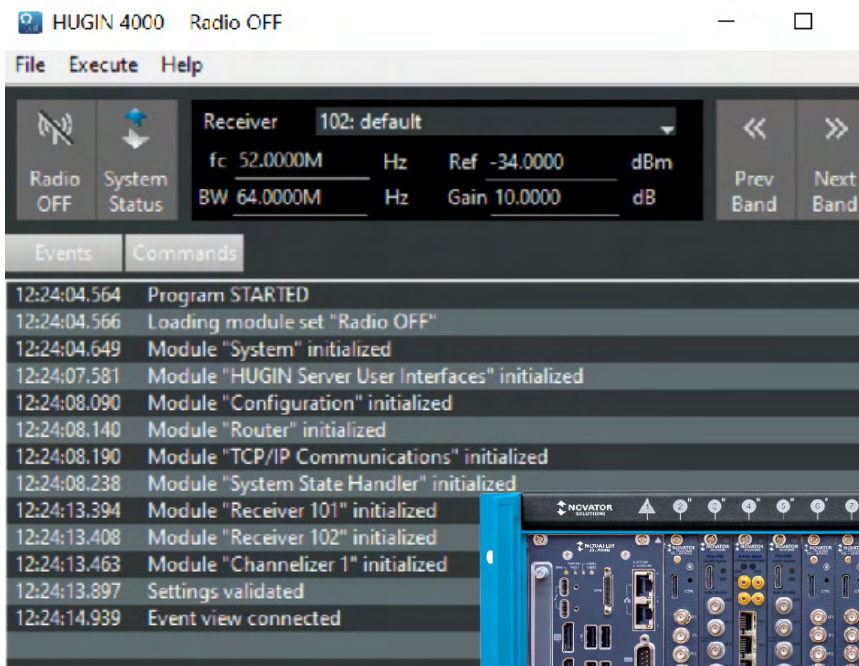

Next generation COMINT RECEIVER PLATFORM HUGIN 4000

INTRODUCTION

HUGIN 4000 is the latest high-end multi-channel receiver platform from Novator Solutions. This platform provides major improvements in performance, functionality and application modes consolidating Novator Solutions' position as a leading provider of receivers for COMINT applications. With 2-12 RF input channels, an aggregated bandwidth between 160 MHz and 960 MHz and up to 6144 DDCs, HUGIN 4000 is a game changer in the domain of COMINT receivers with one of the lowest costs per channel ratio.

HUGIN 4000 Strengths

- Superior sensitivity and high dynamic range
- 2-12 RF inputs channels with an 80 MHz instantaneous bandwidth each
- Frequency range: 2 MHz – 6 GHz
- 960 MHz aggregated bandwidth
- Up to 6144 individually configurable DDCs
- Configurable DDC parameters: Centre frequency, bandwidth gain and choice of IQ or demodulated data output
- AM, FM, SSB & CW demodulation
- Independent and phase coherent tuning
- Server/Client architecture that allows remote operations and seamless streaming of intercepted data
- Intuitive API that enables easy integration with any 3rd party COMINT monitoring software

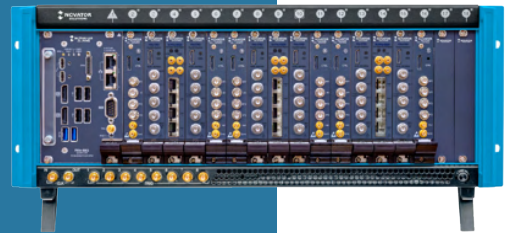

Inside the Box

HUGIN 4000 is based on a modular 19" rack-mountable chassis design. Each receiver module has two individual RF inputs which share 1024 DDCs. Up to six receiver modules can be installed in a single chassis. Real-time analog demodulation and UDP packaging is done in a separate FPGA module.

The FPGA module has two 10Gb Ethernet interfaces and supports two receiver modules or 4 individual RF inputs. A fully configured system with 12 RF inputs uses three FPGA modules which ensures enough data streaming capacity over six 10 Gb Ethernet interfaces. HUGIN 4000 comes with an embedded server which is controlled via 1Gb Ethernet.

HUGIN 4000

PRODUCT ARCHITECTURE

Simplified HUGIN 4000 Data Flow

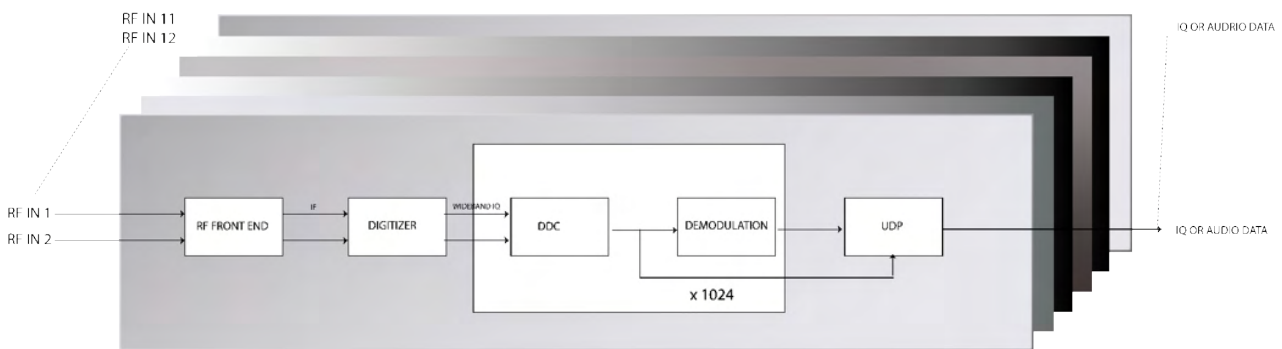

Product Functionality

HUGIN 4000 standard configuration supports monitoring receiver mode with narrowband DDCs. Each receiver input can monitor an 80 MHz band anywhere from 2 MHz to 6 GHz. The narrowband DDCs can be configured individually during run-time. Narrowband IQ data can be streamed as complex IQ data with 54 effective bits or as demodulated audio data. For applications requiring a DDC wider than 40MHz an optional wideband DDC (per RF input) with full 80MHz bandwidth can be added. As an option scanning receiver mode can be added to HUGIN 4000. For applications requiring optimized scanning rates multiple receiver inputs can be reconfigured from monitoring to scanning receiver mode. Besides independent tuning, HUGIN 4000 supports phase coherent tuning. This paves the way for beam forming and direction finding applications in a single receiver system.

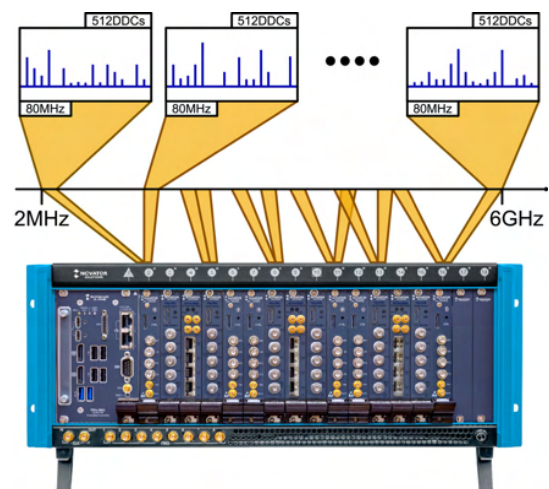

HUGIN 4000

PRODUCT SPECIFICATIONS

Receiver	
RF Receiver Channels (Rx)	2 - 12, SMA Connectors
Input Impedance	50 Ohm
Max Input Power	+17 dBm
Frequency Range	2 MHz - 6 GHz
Instantaneous Bandwidth	80 MHz per RF input, individually Tunable
Tuning Modes	Independent or Phase-Coherent
Tuning Resolution	<1 Hz
ADC	16 Bit
Sampling Rate	500 MHz
FFT Width	4k - 256k Point FFT
RF Gain	50 dB in 1 dB step
Dynamic Range(1)	112 dB
SFDR Single Tone	-85 dBc @ 10.1 MHz (direct path) -80 dBc @123.1 MHz (Superheterodyne path)
Phase Noise	10 & 100 kHz Offset -98 dBc/Hz 1 MHz Offset -109 dBc/Hz 10 MHz Offset -135 dBc/Hz
VSWR	2.35:1
Noise Figure	6 dB (LNA)
Sensitivity (DANL)	-163 dBm/Hz
Linearity	IP3 +10 dBm
IF Rejection	80 dB
Image Rejection	80 dB
Filter Bank 2-100MHz	HP Filters: 2, 20, 30 MHz LP Filters: 30, 40, 83, 100 MHz FM Notch Filter
Filter Bank 100-450MHz	Tunable Low and High Pass Filters, min 20 MHz Bandwidth
Sub-octave Preselectors	390 - 620 MHz 540 - 850 MHz 770 - 1210 MHz 1130 - 1760 MHz 1680 - 2580 MHz 2500 - 3880 MHz 3800 - 6000 MHz

HUGIN 4000

PRODUCT SPECIFICATIONS

Internal reference clock @100MHz	Phase noise: -129dB/Hz @10kHz
Synchronization	Standard: PPS & external 10MHz reference Option: GPS, IRIG-B
DDC channel specification	
Wideband DDC	1 wideband DDC with full 80MHz bandwidth per RF input
Narrowband DDCs	1024 - 6144 (2 RF inputs share up to 1024 DDCs)
DDC sampling resolution	Effective 54 bit (27 bits I & 27 bits Q)
DDC frequency resolution	1 Hz
Digital output	Demodulated audio or IQ - VITA-49 compliant (option)
Demodulated data format	Real (16 bit) - VITA-49 compliant (option)
IQ data format	Complex (64 bit) - VITA-49 compliant (option)
Supported demodulations	AM, FM, LSB, USB, CW
AM filter @8 k output rate	6 kHz, 10 kHz, 20 kHz
FM filter @8 k output rate	10 kHz, 20 kHz, 50 kHz, 100 kHz, 200 kHz
FM filter @96 k output rate	100kHz, 150 kHz
FM filter @192 k output rate	100 kHz, 150 kHz, 200 kHz
LSB and USB filter @8 k output rate	3 kHz
CW filter @8 k output rate	500 Hz
IQ output rate	Configurable from 3 kSps to 50 MSps
IQ filter	Default: 80% of IQ rate
Aggregated output sample rate	Dependent on channel bandwidth and output rate. For 50kHz FM channels @8k output rate, 1024 channels are possible.
Power measurement in dBm	Average power measured over 80 ms.
Squelch	Manual and automatic; hysteresis
AGC mode	Manual & automatic: Fast, medium, slow with configurable attack & decay

HUGIN 4000

PRODUCT SPECIFICATIONS

Server	
Operating System	Windows 10 Professional, 64bit
CPU: Intel® Xeon®	E3-1515M, base: 2.8 GHz, 4 cores W-2245, base: 3.9 GHz, 8 cores
DRAM	32 GB DDR4-2133 32-64 GB DDR4-2666
Hard drive	960 GB removable SSD 500 GB (or greater) SSD
Network interface	2x 1 Gbit (TCP/IP: control) 2-6x 10 Gbit SFP+ copper/fiber (UDP multicast: channel & spectrum data)
I/O ports	2x USB 3.0, 4x USB 2.0, 2x Thunderbolt 3
Video	1x DisplayPort 1.1, 1x DisplayPort 1.2 1x DisplayPort 1.2
Mechanical / Environmental	
Power Supply	100-240VAC 50/60 Hz, 100-120VAC 400Hz
Power consumption	605W - 1120W dependent on system configuration
Form factor	4U - 19" rack mountable chassis
Dimensions	Small system: 177,1x 303,3x463,6mm (HxWxD) Large system: 177,1x 445,5x463,6mm (HxWxD)
Operating Temperature	0-55 C
Operating Altitude	3.000 m

HUGIN 4000

SOFTWARE ARCHITECTURE

HUGIN 4000 has a server application, two client applications and an API for integration in any 3rd party COMINT software environment.

HUGIN 4000 Server

The server application provides configuration and control access via GUI or Windows service.

- Separates all time critical tasks from non-time-critical tasks
- Enables configuration of receiver, DDC and demodulation settings during run-time
- Provides control and configuration access to multiple clients
- Manages UDP multicast streams of wideband spectrum and up to 6144 DDCs
- Logs all server events and server/client communication
- Authorizes remote software updates

HUGIN 4000 clients

HUGIN 4000 comes with two client applications: HUGIN 4000 CONFIG and HUGIN 4000 CHANNEL.

- Allows remote configuration and control of the receiver
- Grants access to view and control individual DDC parameters during run-time
- Provides one live wideband spectrum view and up to five narrowband signal views
- Enables live channel monitoring of data and audio

HUGIN 4000 API

HUGIN has an intuitive TCP/IP API. It includes over 50 well documented JSON coded commands. The API includes integration examples for C, PYTHON and LabVIEW.



HUGIN 4000 Server GUI

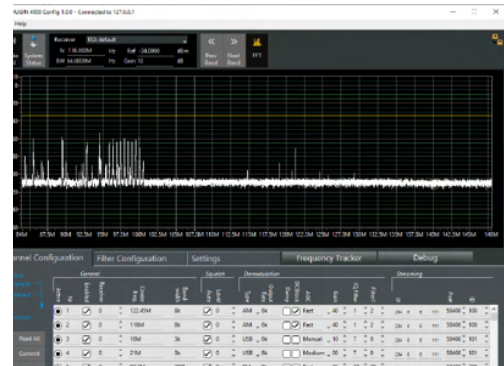

HUGIN 4000 CONFIG GUI

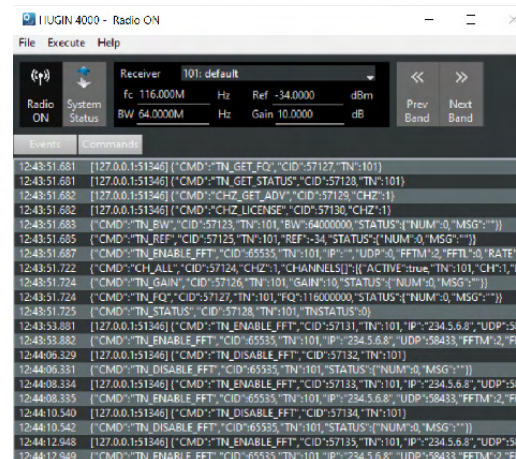

API commands log

HUGIN 4000

PRODUCT CONFIGURATIONS

HUGIN 4000 has several standard configurations ranging from a starter receiver system with 2 RF inputs up to a fully equipped receiver system with 12 RF inputs.

HUGIN 4000 standard configurations

Model	RF in	Aggregated monitoring bandwidth	Narrowband DDCs	System size
HUGIN 4002	2	160 MHz (2x80 MHz)	1024	4U - Small
HUGIN 4004	4	320 MHz (4x80 MHz)	2048	4U - Small
HUGIN 4006	6	480 MHz (6x80 MHz)	3072	4U - Small
HUGIN 4008	8	640 MHz (8x80 MHz)	4096	4U - Large
HUGIN 4010	10	800 MHz (10x80 MHz)	5120	4U - Large
HUGIN 4012	12	960 MHz (12x80 MHz)	6144	4U - Large

Options

- GPS & IRIG-B (HUGIN 4006 requires upgrade to 4U - Large system chassis)
- Wideband DDCs
- Scanning Receiver mode
- VITA-49 compliant (VITA 49.0 data format and VITA 49.2 control)
- 4U - Large system chassis
- In the future, additional options will be available through software upgrades.

Customization

HUGIN 4000 can be customized to any of your projects or mission requirements upon request. The versatile platform combined with our business model helps you to get the best possible receiver system fulfilling your requirements while being cost effective.

HUGIN 4000

GET IN TOUCH

About Novator Solutions

Novator Solutions AB, part of Novator Consulting Group, is a leading provider of products & system development within SIGINT & EW domains. Our highly skilled R&D team applies its extensive know-how in high-speed data processing and software defined radio “SDR” technology to develop next generation CO-MINT receivers and ELINT signal recorders. Our software expertise combined with a modular hardware architecture allows us to provide customized products and complete turn-key solutions tailored to specific project or mission requirements.

Contact

Mail: info@novatorsolutions.se

Call: +46 8-622 63 50

Visit: www.novatorsolutions.com

